

ARB **BASE RACK**

FITTING INSTRUCTION

BASE RACK GUARD RAIL SYSTEM

3/4 RAIL KIT

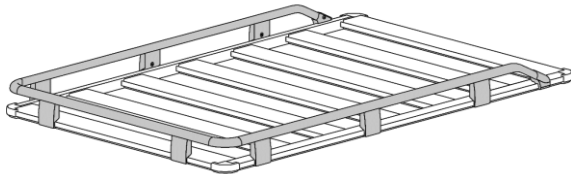

1/4 RAIL KIT

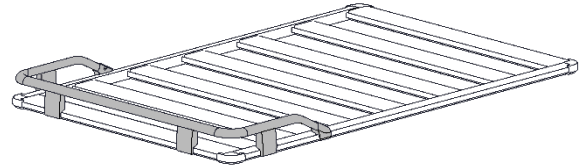

NOTE THE FOLLOWING:

- ◆ This product must be installed exactly as per these instructions using only the hardware supplied.
- ◆ For fitment to ARB BASE RACK only, refer to application guide for relevant part numbers
- ◆ This product or its fixing must not be modified in any way.
- ◆ It is recommended that this product is only installed by trained personnel
- ◆ Fitting Guard Rails to BASE RACK prior to vehicle installation may aid assembly
- ◆ During installation, it is the duty of the installer to check correct operation/clearances of all components
- ◆ Work safely at all times
- ◆ Unless otherwise instructed, tighten fasteners to specified torque
- ◆ Fastener torques are to be checked after first 500km and at vehicle service intervals
- ◆ Guard rails are not a rated tie down point. Do not use guard rails for lashing loads

ARB 4x4 ACCESSORIES

Corporate Head Office

42-44 Garden St
Kilsyth, Victoria
AUSTRALIA 3137

Tel: +61 (3) 9761 6622
Fax: +61 (3) 9761 6807

Australian enquiries
North & South American enquiries
Other international enquiries









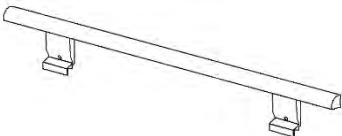
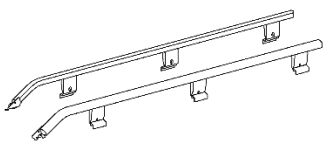

sales@arb.com.au
sales@arbusa.com
exports@arb.com.au

www.arb.com.au

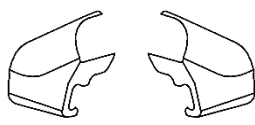
FITTING REQUIREMENTS

REQUIRED TOOLS FOR FITMENT OF PRODUCT:

4mm Hex/Allen key	Screwdriver Phillips #2
T30 Torx (provided)	10mm Spanner/Wrench
T40 Torx (provided with rack fit kit)	

APPLICATION.	PART NO.	QTY.	DESCRIPTION
	-	1	Cross Rail Assembly
	-	1R/1L	Side Rail Right/Left (Pair)
	3163217	2	Corner Casting
	3163215	2	Corner Blank Cap
	6582491	4 or 8	Cast Upright Clamp
	6582489	2	Clamping Bracket
	3163213R/L (PAIR)	1R/1L	Cover Cap Right/Left
	6151924	4 or 8	Torx Screw M8x20mm Black Yellow Patch
	6151623	6	Torx Screw M6x16mm Black Blue Patch
	6151223	2	Nyloc Nut M6 Black
	4584329	4	Washer M6x12mm Black
	6151626	2	Screw Self-tapping 4.8(#10)x16mm
	6151922	2	Screw M6x16mm Countersunk

FITTING PROCEDURE

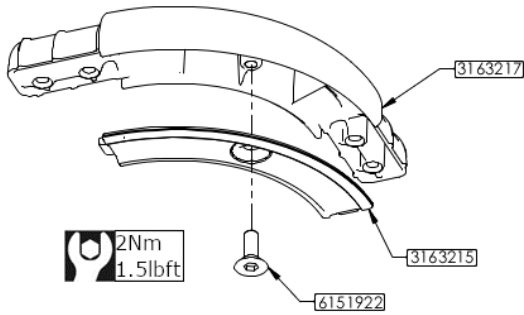

1. Secure the corner blank cap to the corner castings with M6x16 countersunk screw
2. Repeat for all corners

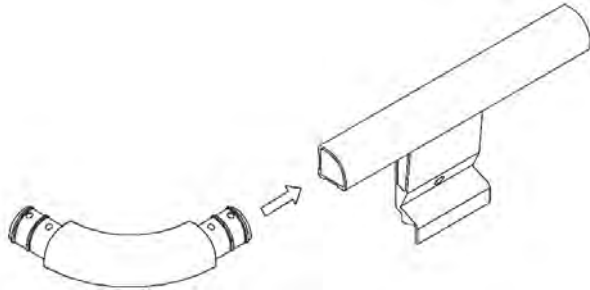

3. Insert corner casting into side rail as shown

**Hint: The casting is a tight fit
It may be necessary to lubricate ribs to ease fitment**

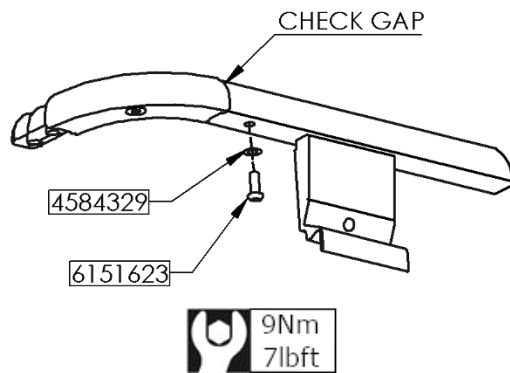

4. Check the gap is closed between the rail and casting
5. Secure the corner with M6x16 Torx screw and washer

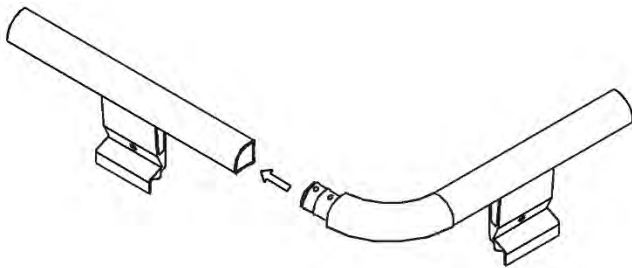

6. Insert the side rail assembly into the cross rail as shown



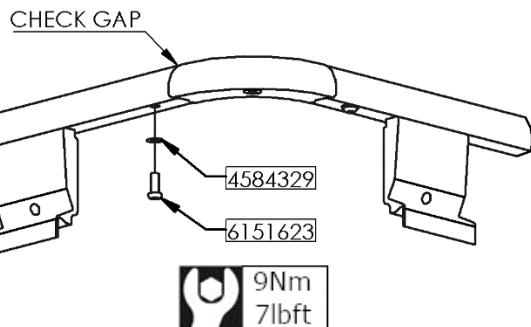

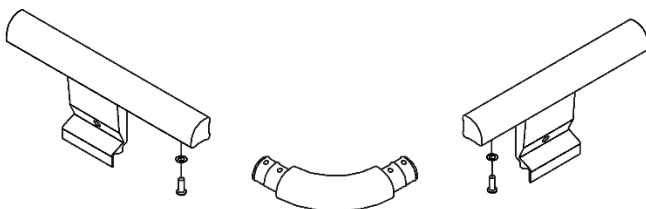

**Hint: The casting is a tight fit
It may be necessary to lubricate ribs to ease fitment**

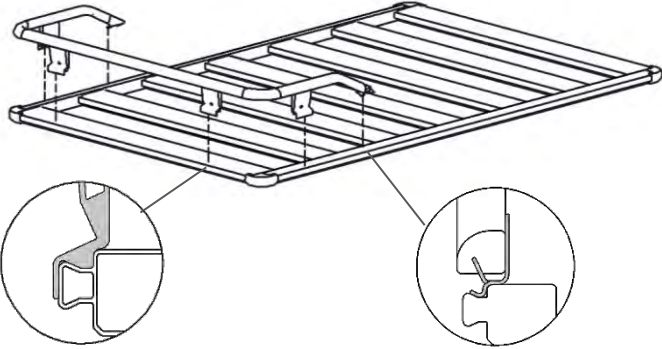
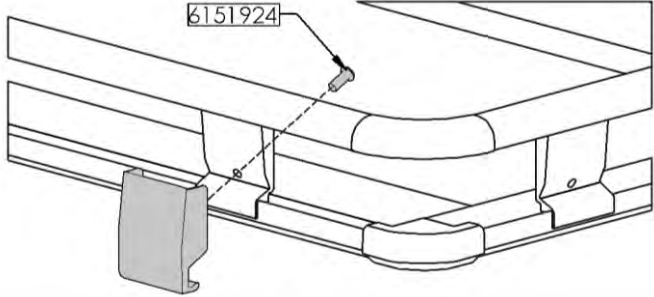

7. Check the gap is closed between the rail and casting
8. Secure the corner with M6x16 Torx screw and washer

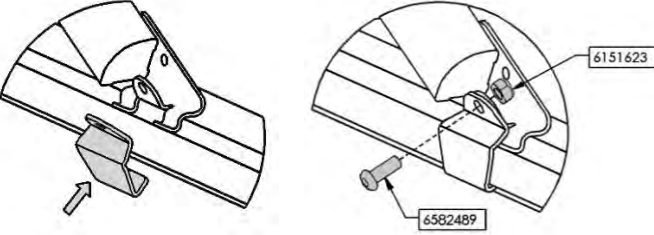

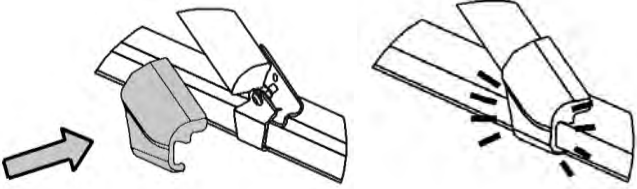
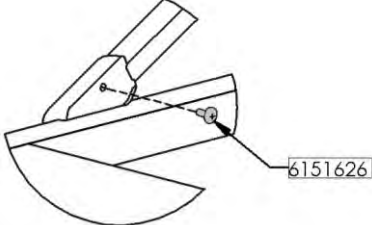
9. Repeat steps 3-8 for the opposite corner

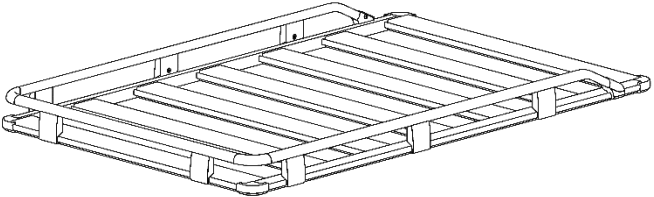
	<p>10. With the help of a second person, lower rails on to the rack</p> <p>11. Ensure the uprights and end brackets are locked in to the BASE RACK dovetail as shown</p>
 <p style="text-align: center;"> 22Nm 16lbft</p>	<p>12. Fit cast clamp over upright. Secure with an M8x20 Torx screw</p> <p>13. Repeat for all uprights</p>
 <p style="text-align: center;"> 9Nm 7lbft</p>	<p>14. Fit the clamping bracket over the rack and end bracket</p> <p>15. Secure with M6x16 Torx screw and M6 Nut</p>
	<p>16. Snap fit the cover cap</p>
 <p style="text-align: center;"> 1.0Nm 0.7lbft</p>	<p>17. Secure the cover cap with self-tapping screw</p> <p>18. Repeat steps 14-17 for 2nd cap</p>
	<p>19. Check all fastener torques, check the roof is clean and clear of parts</p> <p>20. Place fitting instructions in safe location for future reference</p>